

Door Hardware

High Quality

32



Zone door hardware is made from high quality materials, solid brass or stainless steel.

ZON001 Stainless Steel Door Co-ordinator



ZON002 Stainless Steel Indicating Bolt



ZON003 Stainless Steel Security Door Chain

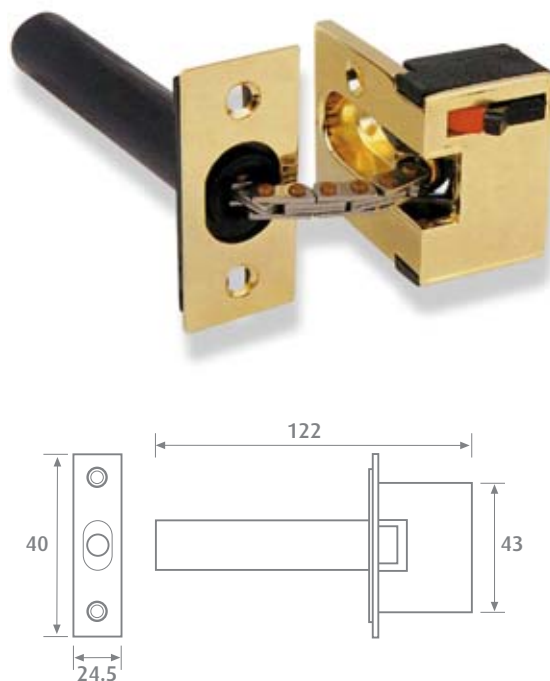

32

Door Hardware



33

Miscellaneous

ZON050 Solid Brass Doorbolt



Product code	Width	Length	Finish
Zon 050	25mm	75mm	PB
Zon 051	25mm	125mm	PB

ZON090 Solid Brass Escutcheon

PB/SCP Finish

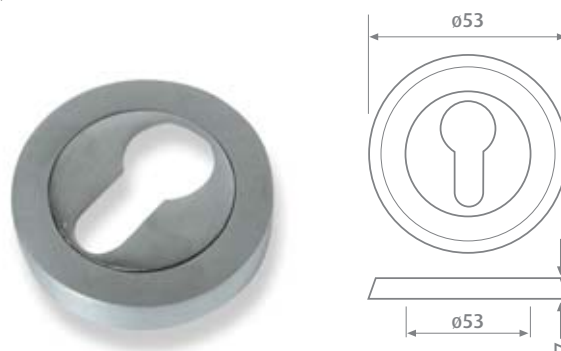

ZON060 Brass Security Door Guard

PB/SCP Finish

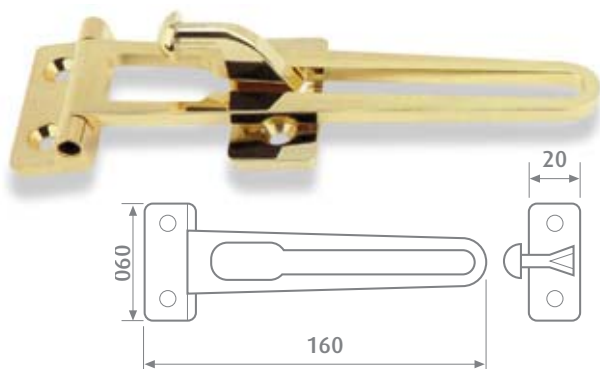

ZON091 Hardened Steel Security Escutcheon

PB/SCP Finish



ZON070 Solid Brass Door Viewer

PB/SCP Finish

200° Glass Lens

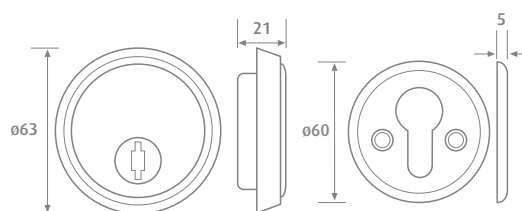
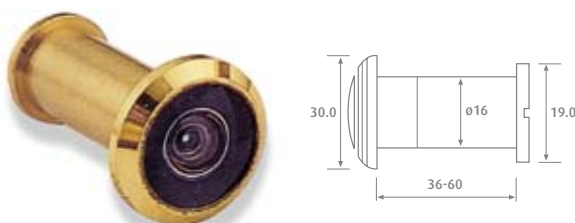

33

Z300 Series

Door Closer

34



General Specification

- 1 Hour Fire Rating
- Hydraulic control
- Adjustable latching speed
- Adjustable closing speed
- Supplied with parallel arm bracket
- Aluminium body
- Steel arm
- Universal screw pack
- 3 spring strengths

Certifire Approved
Conforms to BS EN154

Technical Specification

Underwriter Laboratories Inc. listed. The series is a recently developed economical door closer with many of the engineering characteristics of a top range closer. Compact design. Die cast aluminium housing. Universal application. Non handed for standard, top jamb, or parallel arm installation. Available in 3 strengths. Fixing for both metal and timber doors.

Adjustment

Two independent valves providing hydraulic control from 180 degrees of closing sweep and 15 degrees of latching. Fully adjustable after installation

Finish

Excellent silver finish. Other colours obtainable on special request.

Accessories

Flat drop bracket for installation on door or door frame when direct fixing is not possible. Hold open arm adjustable for any degree of retention. Parallel bracket for hold-open arms. Special purpose accessories, to cover the most difficult of applications are also obtainable on special order.

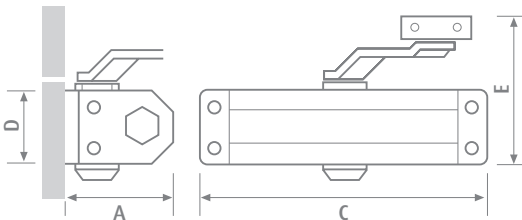

Closing Range & Adjustment

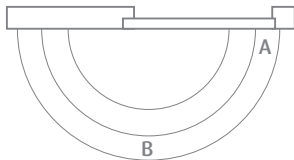

A. Latching Range
B. Closing Range

Closer Dimensions		300 Series		
		302	303	304
Projection from Door	A	60.2	60.5	60.6
Height of closer body	B	41	41	41
Length of closer body	C	182	182	182
Top of door to bottom of closer	D	49	49	49
Overall height	E	102	102	102
Approx. shipping weight in kgs		1.3	1.3	1.3